

Article number: 439500170

Description: Rota-fix shaft-hub connection F170x225  
Steel

Note: Self centering. Very high torque

## Measures

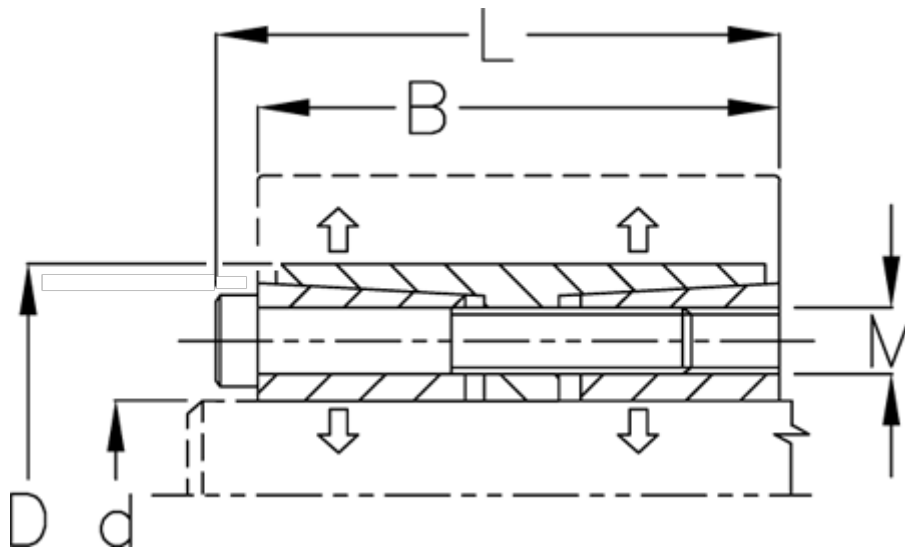

B mm	= 146
d H8 mm	= 170
D mm	= 225
Fit tolerance	= Aksel h8, Nav H8
F kN torque	= 1100.0
L mm	= 162
M mm	= M16
P N/mm <sup>2</sup> surface pressure on shaft/hub	= 100

Surface roughness	= R? ? 3.2 µm
T N m torque	= 95000
Ts N m bolt tightening torque	= 355.0